



Research article

Stability analysis and design of support system for adits of the gold deposits of Mazraeh-Shadi using numerical modeling

Mohammad Darbor^{1*}, Hamid Chakeri¹, Milad Manafi², Akbar Balani¹

1- Dept. of Mining Engineering, Sahand University of Technology, Tabriz, Iran

2- Dept. of Mining Engineering, Amirkabir University of Technology, Tehran, Iran

*Corresponding author: E-mail: darbor@sut.ac.ir

(Received: February 2024, Accepted: May 2024)

DOI: 10.22034/ANM.2024.21237.1625

Keywords

Gold deposits
Tunnel
Support system
Rock bolt
GRC
Numerical modeling

Abstract

The present study proposes a suitable support system for the underground tunnels of the gold deposits of Mazraeh-Shadi in the East Azerbaijan Province of Iran using numerical modeling. The stability of the tunnels was evaluated using the data obtained from the numerical modeling, the ground reaction curve (GRC), the longitudinal deformation profile (LDP), permissible displacements according to the Sakurai relationships, and the load imposed on the support system of the tunnels. Due to the very large dimensions and high computational costs, the adits were modeled at the depths of 1830 and 1870 meters. According to the results and the diagram of the proposed support system based on Q and the cross-section of the tunnel, a support system made from fiber shotcrete with a thickness of 90-120 mm, along with rock bolts regularly installed, is proposed. At the intersections and the tunnel portal, a stronger support system had to be used, and in the tunnel portal the reinforcement system, such as the implementation of shotcrete on the sloped surface, should be taken. At the level of 1870 meters, implementing shotcrete with a thickness of 12 cm and a safety factor of 1.2 was sufficient. At the level of 1830 meters, the shotcrete required to be strengthened. For this purpose, a layer of steel mesh or a restraining lattice with a spacing of 2 meters was used. The proposed support system is sufficient and appropriate given the relatively small dimension of the tunnels and their temporary use and according to the Sakurai criterion, the experimental methods, and the engineering judgment.

1. INTRODUCTION

Nowadays, numerical methods are among the most powerful tools used in engineering problems, especially in design and sensitivity analysis. These methods provide a suitable perspective of the governing mechanism of a problem considering the most influential factors in the analysis results. The main objectives of numerical modeling in geotechnical engineering can be divided into two categories: qualitative analysis and quantitative analysis. In a qualitative analysis, the results are not expressed in numbers. Sensitivity analyses and fundamental studies are

among this group. Meanwhile, in quantitative analysis, the absolute values of the results are crucial and generally used in designs and back analyses [1-7].

Modeling the real condition of the ground is very difficult due to the uncertainties of the subsurface rock mass, including geotechnical properties and distribution of the structural features. As a general result, the type of analysis (continuous or discontinuous) must be chosen based on several factors, including the geometry of the model, the geological and structural conditions, and the preliminary prediction regarding the main mechanism of the instability

(structure control or stress control). [1-3] The FLAC 3D software, which is based on the finite difference method, is used to analyze various geotechnical structures. The structures made from soils, rocks, or any other materials can be simulated and analyzed using this software. It can also analyze the behavior of materials with plastic deformations after yielding. The behavior of each element is affected by its boundary conditions, the forces acting on it, and the behavior model defined for it. If the stress on a material is high, its behavior enters the plastic range, resulting in residual strain [1-2]. The ground response curve (GRC) is a useful method for designing support systems for underground excavations. Analytical methods have limitations in modeling tunnels supported by grout bolts [8].

Bhasin and Høeg (1998) studied the joint spacing behavior and joint resistance parameters in the rock mass around large excavations [2] and Shen and Barton (1997) studied the effects of joint spacing and joint orientation on the disturbed zones (fracture zone, tunnel zone and shear zone) around the tunnels in the jointed rock mass have used UDEC [3]. Chryssanthakis et al. (1999) investigated the effect of reinforced shotcrete and construction sequences on the stability of tunnels [1]. Using numerical modeling, Palassi et al (2006), compared GRC curves for a tunnel supported by grouted rock bolts [8]. Sharifzadeh et al (2008), investigated the stability of the adits in the Jajarm bauxite mines through rock mass classification and numerical modeling using the UDEC software and recommended a support system consisting of steel sets and concrete segments [9]. Wang et al. (2011) performed a three-dimensional analysis using continuous and discontinuous models in 3DEC; in this study, to understand the effects of discontinuities, geomechanical parameters of rock mass and discontinuities and support system were studied on rock behavior [10]. Using the data collected from the laser scanner, Fekete and Diederichs (2013) developed a discontinuous model using 3DEC to simulate the structural controlled failure around the tunnel in the block rock mass [4]. In the research of Shreedharan and Kulatilake, 3DEC was used to check the stability of tunnels with different shapes in the deep coal mine of China; Also, the effectiveness of the maintenance system was evaluated using an immediate and near-real stress release installation process [11]. In order to determine the ultimate ground pressure on a circular tunnel in a continuous medium, Rahmamejad et al (2015), used the Duncan-Fama solution and Janssen-Kötter and Caquot rigid plastic models, assuming an elastic-perfectly plastic model with the cohesionless behavior in

the broken zone [12]. GolPansad (2018) has investigated the impact of tunnel excavation on line 7 of the Tehran Metro and its interaction with the existing aqueduct. Various methods to evaluate ground instability due to tunnel excavation, including; Semi-empirical, analytical and numerical methods are suggested. GolPasand investigated the stability analysis of this tunnel using semi-empirical, analytical and numerical methods and compared the results with the real instability in place. The comparison showed that the numerical method is more accurate and suitable and shows more reliable results [5]. Xu et al (2021), presented a modified ground response curve (GRC) for over-excavation in strain-softening rock masses based on the Zhang-Zhu strength criterion [13].

The present study proposes a suitable support system for the underground tunnels of the gold deposits of Mazraeh-Shadi in the East Azerbaijan Province of Iran using numerical modeling. The stability of the tunnels was evaluated using the data obtained from the numerical modeling, the ground reaction curve (GRC), the longitudinal deformation profile (LDP), permissible displacements according to the Sakurai relationships, and the load imposed on the support system of the tunnels.

2. LOCATION OF THE GOLD DEPOSITS OF MAZRAEH-SHADI

The gold mine of Mazraeh-Shadi is located in the northwest of Iran in 110 kilometers north of Tabriz, and in the high mountain area of East Azarbaijan province. The access road to this mine is from the Varzeghan axis to Kharvana and the Chichaklo side road after Sharafabad village (Fig. 1). The gold mine of Mazraeh-Shadi is the second gold mine of Varzeghan city with joint investment of Iran and China. The grade of this mine is seven grams per ton and its reserves are two million and 175 thousand tons.

Two modes were considered for the modeling of the tunnels of gold mine of Mazraeh-Shadi. The main tunnels were modeled far from the tunnel face in two dimensions. Meanwhile, the intersection of the main tunnels and sub-tunnels was modeled in three dimensions. The modeling was performed using the Hoek-Brown (1980, 1981 and 1997), failure criterion, which has been successfully used in the design, along with the limit equilibrium and numerical methods, over recent years. In this criterion, the degree of disturbance of a rock mass is expressed by parameter D (which equals zero for rock masses without any disturbance and one for very disturbed ones) [14-17]. In this study, since the

adits were excavated using the blasting method, the disturbance factor, D , was considered one. Moreover, the ratio of the horizontal stress to the vertical stress (K) was considered 0.8. Due to the very large dimensions and high computational

costs, only two tunnels located at the depths of 1830 and 1870 meters were studied separately. The initial long section of each adit was modeled separately from its intersection. Fig. 2 depicts the mentioned sections for different levels.

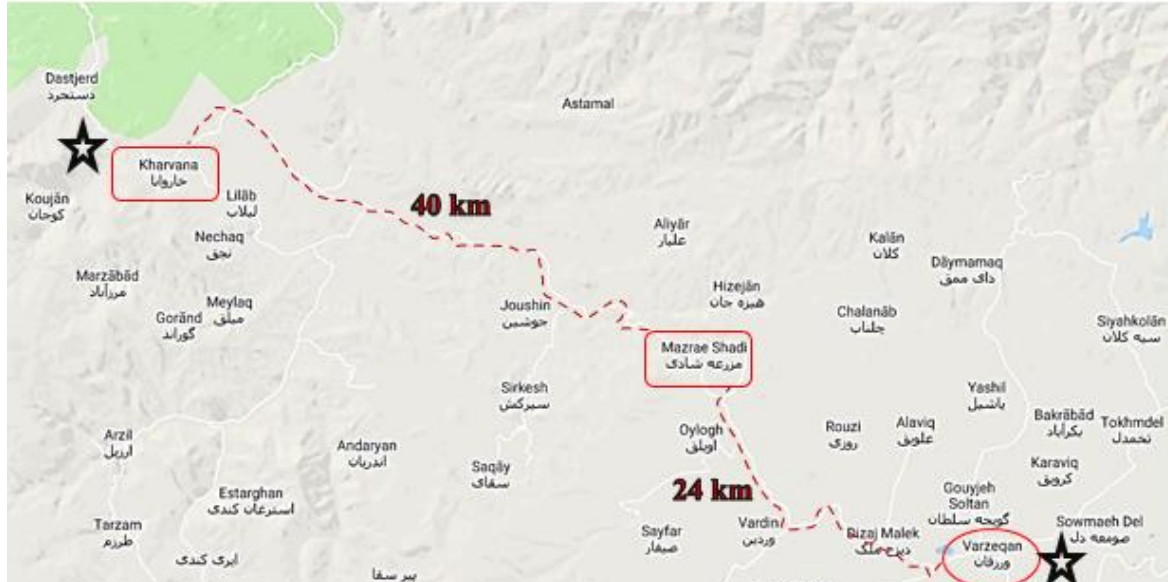

Fig. 1. The location of the gold mine of Mazraeh-Shadi in the northwest of Iran.

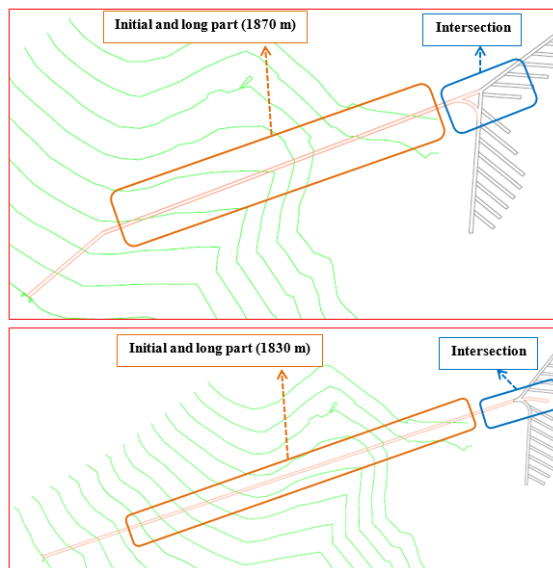

Fig. 2. Different sections of the adits.

3. STABILITY ANALYSIS AND DESIGN OF SUPPORT SYSTEM

A D-shaped section with a span of 2.8 meters and a depth of 2.8 meters was designed for each tunnel. The general dimensions of the model were also chosen in such a way that the boundary of the model was far enough from the inner boundary of the tunnels. According to the location of the tunnels and the topography of the area, the overburden of the initial long section of the adit (at the depth of 1870 m) varied from zero (at the

entrance portal) to 80 meters (after about 280 meters of the tunnel advance). Given the topographic slope and the lack of a topography map for the end parts of the adit at the level of 1870 meters, the overburden was considered equal to 100 meters in this part to consider the most critical situation. The overburden of the initial long section of the adit at the level of 1830 meters varied from zero (at the entrance portal) to 80 meters (after about 600 meters of face advance). Given the lack of a topography map and according to the topographic slope, the overburden was considered equal to 140 meters in the end section of the adit. Twenty-five meters of the overburden was modeled using volumetric elements, while the remaining was considered stress boundary conditions (Fig. 3).

The geotechnical properties of the rock mass were estimated by applying the intact rock properties and GSI, along with other necessary parameters in the RocLab software. Table 1 lists the input parameters of the RocLab software, and Table 2 summarizes the geotechnical properties of the rock mass for different sections (output of the RocLab software). In Table 2, the constants m_b , s , and a are the Hoek-Brown coefficients for the rock mass. The installation of a support system immediately after the excavation of the tunnel causes a heavy load on the system. Therefore, the design must be conservative. The ground reaction curve (GRC) and longitudinal deformation profile

(LDP) were used to determine the value of the stress release before installing the support system.

3.1. The Ground Reaction Curve (Grc)

The GRC curve was plotted using Hoek's analytical method, assuming hydrostatic conditions, a circular tunnel with an equivalent diameter, and a constant vertical stress equal to the horizontal stress in the center of the tunnels. Fig. 4 demonstrates the GRCs plotted for the adits at the two levels. Using the numerical method, the GRC was plotted for the D-shaped cross-section considering the Hoek–Brown behavior model and a horizontal-to-vertical stress ratio of 0.8 (Fig. 5).

Table 1. Input parameters of the RocLab software

Uniaxial compressive strength (MPa)	Unit weight (KN/m3)	GSI	mi	D
25	25	45	8	1

Table 2. Geotechnical properties of the rock mass (output of RocLab software)

Parameters	Level of 1870	Level of 1830
Depth (m)	100	140
Elastic modulus (MPa)	1400	1400
cohesion (MPa)	0.198	0.243
Friction angle (degree)	28.1	25.7
Tensile strength (MPa)	0.005	0.005
m_b	0.248	0.248
s	0.000045	0.000045
a	0.511	0.511
Uniaxial compressive strength (MPa)	0.15	0.15

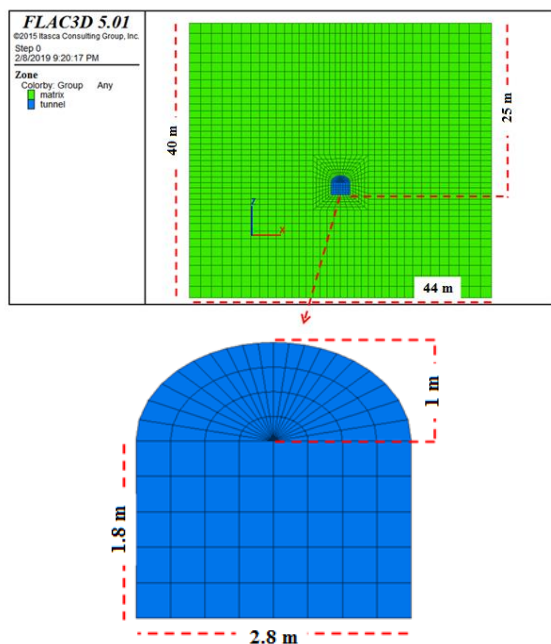

Fig. 3. Different sections of the adits.

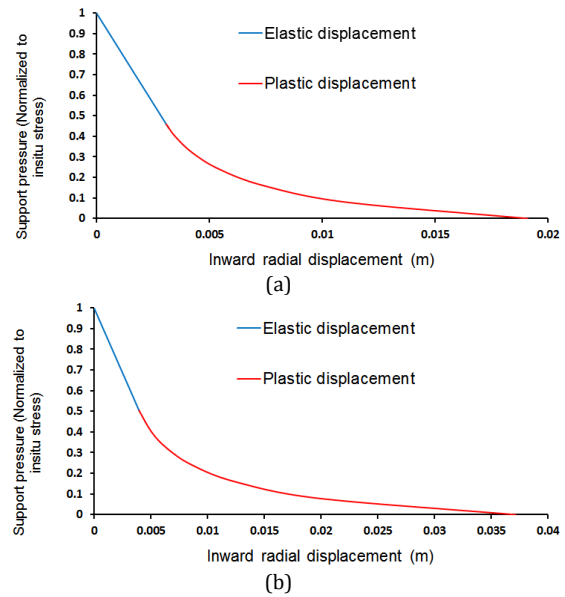

Fig. 4. The GRCs plotted using Hoek's analytical method: (a) level of 1870 meter (b) level of 1830 meter.

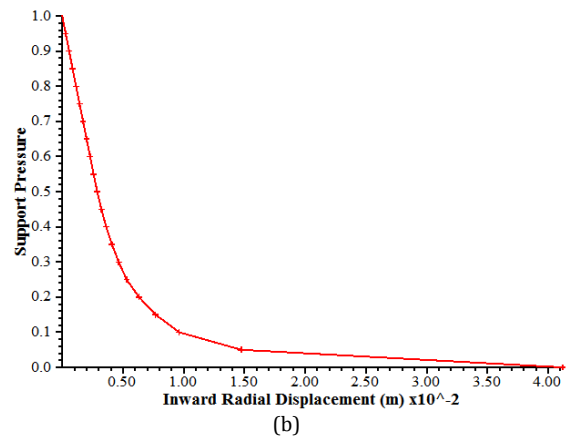
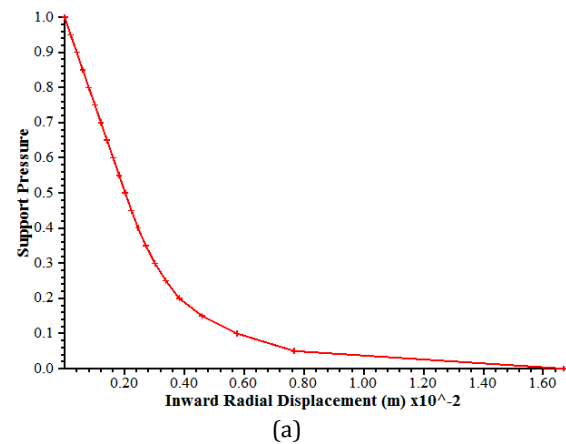

Fig. 5. The GRCs plotted using the numerical method: (a) level of 1870 meters (b) level of 1830 meters.

3.1.1. The tunnel at the level of 1870 m

According to Fig. 5 (a), the ratio of the critical internal pressure to the in-situ stress was about 40%. In other words, the plastic displacements occurred when the internal pressures were lower

than 40% of the in-situ stress. In such conditions, the dead load was applied to the support system. The tunnel was self-supporting, and its total displacement was about 17 mm without installing the support system. Fig. 6 (a) illustrates the vertical displacement around the tunnel without applying the internal pressure and after reaching the equilibrium mode. Considering the stress of almost 2.5 MPa and the elastic modulus of about 1400 MPa, a low displacement was expected.

3.1.2. The tunnel at the level of 1830 m

According to Fig. 5 (b), the ratio of critical internal pressure to the in-situ stress was about 40%. The tunnel was self-supporting, and the final displacement was about 42 mm. The vertical displacement around the tunnel without applying the internal pressure and after reaching the equilibrium mode is shown in Fig. 6 (b). The displacement at the level of 1830 meters was higher than that at the level of 1870 meters since the stress field was higher at the level of 1830 m.

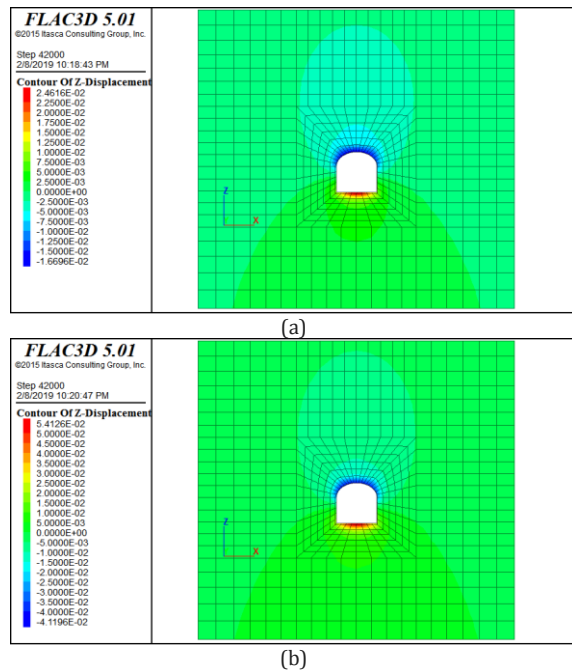

Fig. 6. The vertical displacement without applying internal pressure and after reaching the equilibrium: (a) level of 1870 meters (b) level of 1830 meters.

3.2. The Longitudinal Deformation Profile (Ldp)

The LDP is the profile of radial displacement along the axis of the excavation section without any support system installed. In this study, a numerical method was used to plot the LDP curve for the D-shaped cross-section of the tunnel using the Hoek–Brown criterion and a stress ratio of 0.8. Accordingly, the tunnel without the support system was excavated for about 28 meters. The

dimension of the model in the direction of the excavation was 40 meters. The vertical displacement after excavation of the model for about 28 meters, along with the LDP curves (in two forms: with absolute values of displacement and with the displacement normalized by the maximum displacement) are illustrated for the levels of 1870 m and 1830 m in Fig. 7 and 8. The following discusses the plotted LDP curves.

3.2.1. The tunnel at the level of 1870 m

As shown in Fig. 7 and 8, the displacement at the tunnel crown was 2.4 mm (15% of the maximum displacement). According to the GRC, 50% of the stress was released due to the vertical movement in front of the face. Moreover, as shown in Fig. 5 (a), the critical internal pressure was estimated at about 40% of the in-situ stress with a corresponding displacement of 3 mm (18% of the maximum displacement). At displacements of higher than 3 mm, the behavior became plastic. According to the LDP curve, the displacement at a distance of 1 meter from the face was about 7 mm (more than 3 mm). Thus, the support system had to be installed immediately after the excavation.

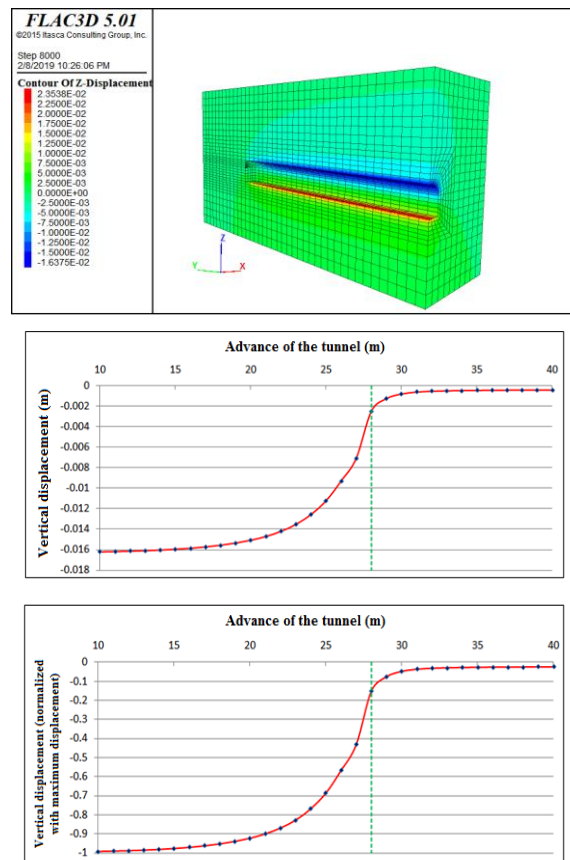

Fig. 7. Vertical displacement and the LDP curve for level of 1870.

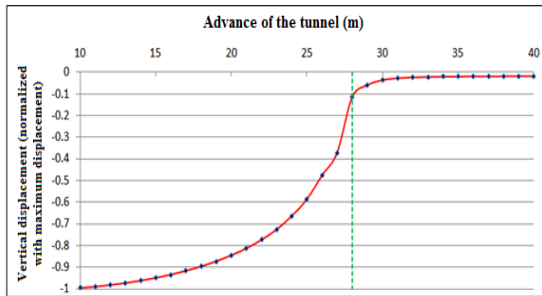
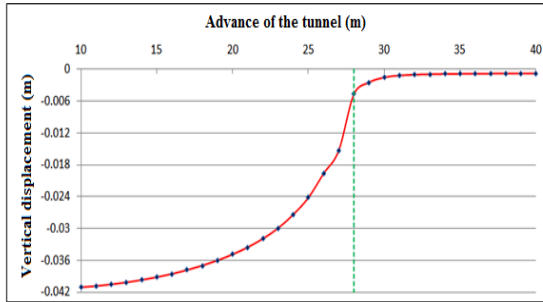
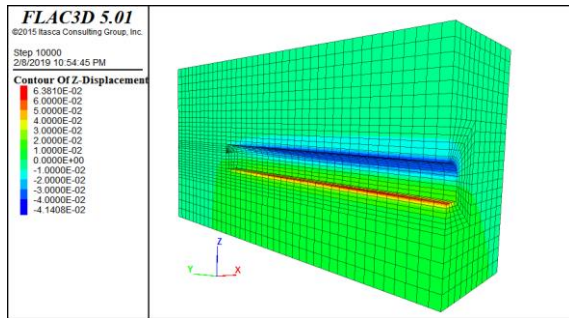
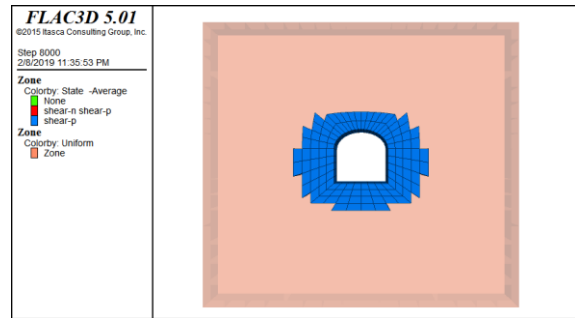

Fig. 8. Vertical displacement and the LDP curve for level of 1830.

3.2.2. The tunnel at the level of 1830 m

As shown in Fig. 7 and 8, a displacement of almost 4 mm occurred at the top of the tunnel face, and according to the GRC (Fig. 5 (b)), the stress release was about 55%. Furthermore, as mentioned, the critical internal pressure was estimated at about 40% of the in-situ stress (i.e., 60% stress release). Since the released stress was close to the stress release corresponding to the critical pressure, the support system had to be installed immediately after the excavation.

The radius of the plastic zone around the tunnel was numerically modeled, assuming no installed support system. The thickness of the plastic zone around the tunnel equaled approximately 2.5 and 4 meters at the levels of 1870 and 1830 meters, respectively (Fig. 9).



(a)

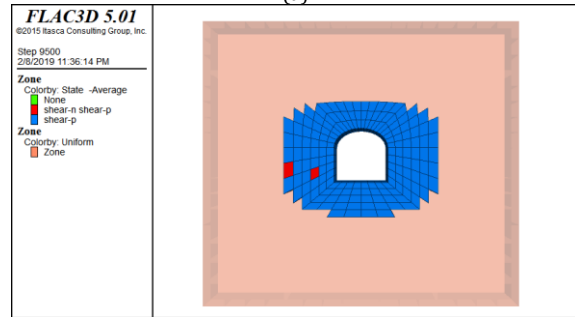

(b)

Fig. 9. The plastic zone around the tunnels without any support system installed at the: (a) level of 1870 meters (b) level of 1830 meters.

3.3. The Permissible Displacement

Sakurai, S (1981), suggested that the stability of a tunnel can be evaluated based on the strain occurring in the rock mass around it. According to this criterion, the tunnel is unstable in level 1 of the danger warning. The level 2 of danger warning has been proposed as the basis for designing the support system, and level 3 indicates short-term stability. The permissible displacement based on level 2 was calculated at 8.3 mm given the radius of the tunnel (1.4 m) and the elastic modulus (1400 MPa) (Fig. 10).

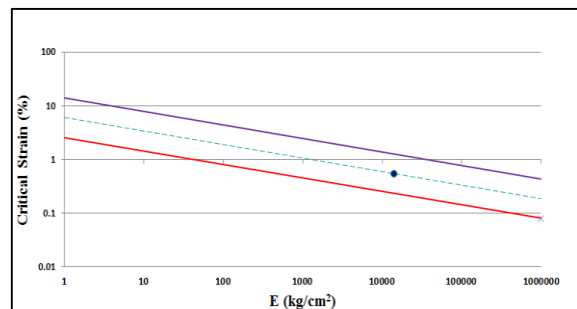

Fig. 10. The permissible strain based on the Sakurai criterion.

3.4. The Applied Load On The Tunnel Support System

The value of the load applied is among the important factors in designing a support system, which can be obtained using experimental, analytical, and numerical methods. The load on

the support system was obtained using the Terzaghi method. Terzaghi (1946) presented the first classification method for estimating the burden [18]. Rose proposed a modified version of the Terzaghi method in 1982. This classification is valid for tunnels located at depths higher than 1.5 (B+Ht), in which B indicates the width of the plastic zone, and Ht denotes the tunnel height. Based on this classification, the height of the burden was 5-6 meters, and the load on the support system was 150 kPa.

3.5. The Ground Reaction Curve (Grc)

The load on a support system can be determined using the GRC and displacement. According to the permissible displacement obtained from the Sakurai criterion (8 mm), the load on the support system equaled 5% and 16% of the in-situ stress (560 kPa) for the levels of 1870 meters and 1830 meters, respectively. Moreover, based on the critical pressure limit (without any plastic zone formed around the tunnel), the load on the support system equaled 1000 kPa and 1400 kPa (40% of the in-situ stress) for the levels of 1870 meters and 1830 meters, respectively. Using the numerical modeling and without installing any support system, the thickness of the plastic zone (which can be considered equal to the height of the loadstone or loosening) was obtained at about 2 and 4 meters for the levels of 1870 and 1830 meters, respectively. According to the results of different methods, the burden on the support system for the levels of 1870 and 1830 meters was estimated at about 250 and 560 kPa, respectively.

3.6. Proposing A Suitable Support System

The strength and adequacy of a support system are checked based on the value of the induced

internal forces in it. Since the analytical relationships to determine the internal forces have been presented for circular sections, numerical modeling was used to determine the internal forces in this study. To optimize the proposed support system based on the Q system, different modes were considered, including the implementation of shotcrete with a thickness of 12 cm, shotcrete and a layer of steel mesh, and shotcrete, along with a lattice installed at the distance of 2 meters.

3.6.1. The support system is made of shotcrete with a thickness of 12 cm

The load on the support system for the level of 1870 meters was considered 250 kPa (10% of the in-situ stress). Accordingly, the required stress release was applied and then, the support system was installed. Fig. 11 depicts the displacements before and after the installation of the support system. According to the figure, the displacement before the installation of the support system (the displacement corresponding to the stress release) was equal to 5.8 mm, while the total displacement after the installation of the support system equaled 6.1 mm. The total displacement was lower than the corresponding displacement of the Sakurai criterion (8.3 mm). Fig. 12 illustrates the interaction diagrams used to check the strength of the support system, along with the components of bending moment-axial force and shear force-axial force curves. Analytical relationships, assuming a confidence factor of 1.5, were used to plot the interaction diagrams. The compressive strength, tensile strength, and elastic modulus of the shotcrete were considered equal to 28 MPa, 2 MPa, and 16 GPa, respectively.

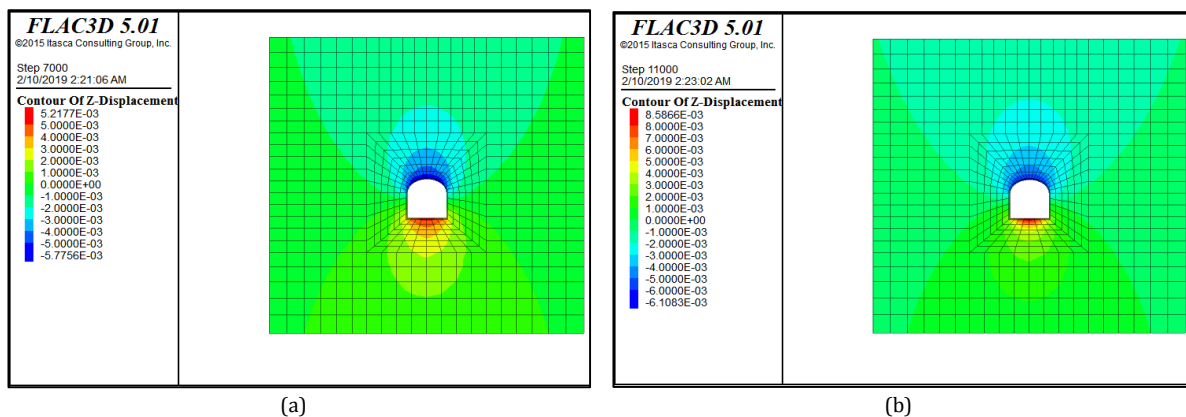

Fig. 11. The displacement: (a) before (b) after installation of the shotcrete support system (level of 1870 m).

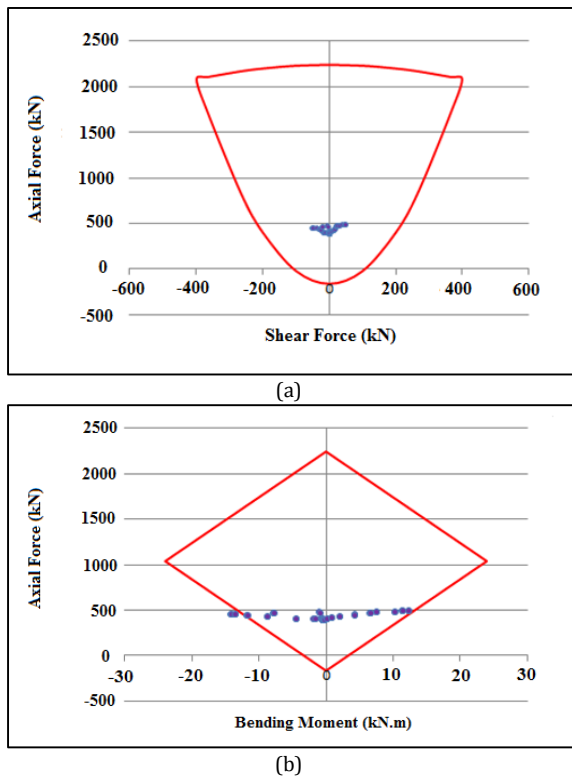

Fig. 12. (a) The shear force - axial force (b) The moment - axial force interaction diagrams for the shotcrete support system (level of 1870 meters).

The low tensile strength is a disadvantage of shotcrete. According to the moment-axial force interaction diagram, shotcrete did not have enough strength in the tunnel wall section and failed under tension. According to the shear force-axial force diagram and the distance of the points from the boundary, the shotcrete had sufficient strength against shear and pressure. According to the load on the support system that was considered 560 kPa (16% of the in-situ stress) for the level of 1830 meters, the support system, was installed after applying for the required stress release in the numerical modeling. The displacements before and after the installation of the support system are shown in Fig. 13. As can be seen, the displacement corresponding to the stress release (before the installation of the support system) was equal to 7.4 mm, while the total displacement after the installation of the support system equaled 8.3 mm, which is equal to the value obtained from the Sakurai criterion. Fig. 14 shows the interaction diagram (assuming a safety factor of 1.5), along with the bending moment-axial force and shear force-axial force curves. According to the moment-axial force interaction diagram, shotcrete did not have enough strength against the load. Therefore, it was necessary to strengthen the support system.

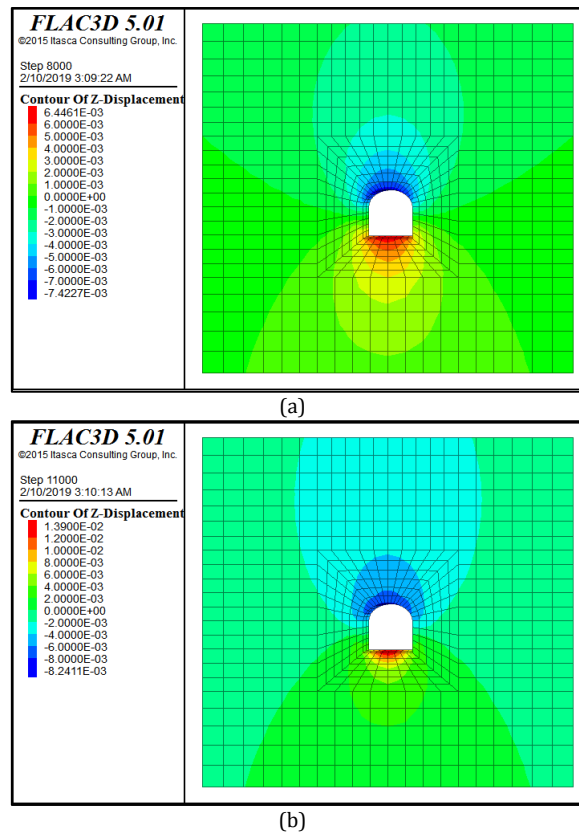

Fig. 13. The displacements: (a) before (b) after the installation of the shotcrete support system (level of 1830 m).

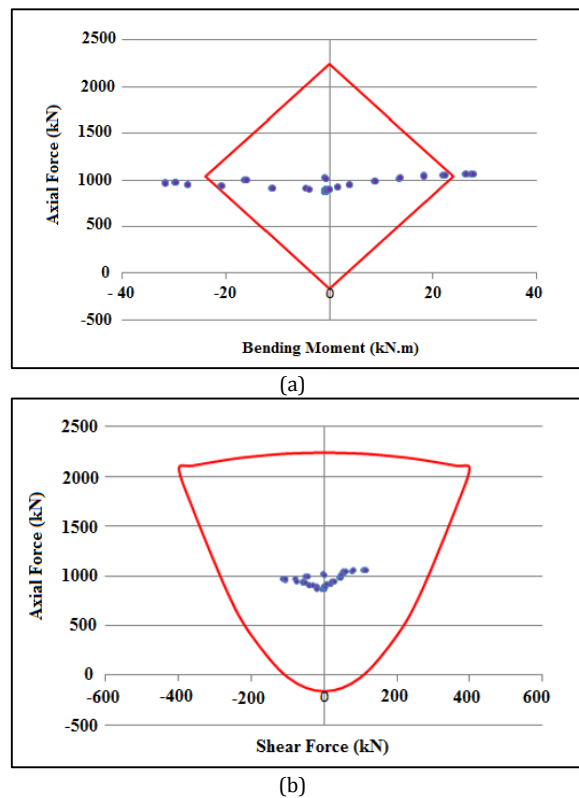

Fig. 14. (a) The moment-axial force (b) The shear force-axial force interaction diagrams for the shotcrete support system (level of 1830 m).

3.6.2. The support system is made from shotcrete with a thickness of 12 cm, along with a layer of steel mesh

A layer of steel mesh was used to enhance the tensile strength of the support system. The Sap 2000 software was used to plot the interaction diagram. Fig. 15 shows a view of the simulated support system. The concrete strength reduction coefficient was considered according to ACI-318-99 regulations, and the distance between the steel mesh and the excavation wall was considered

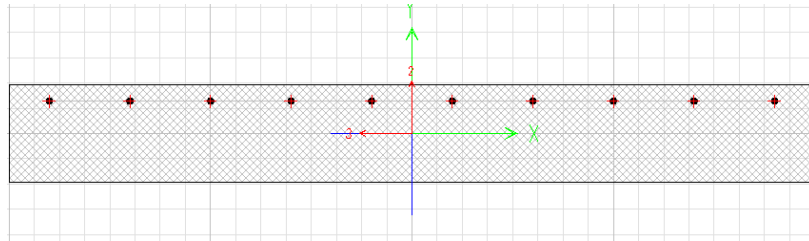
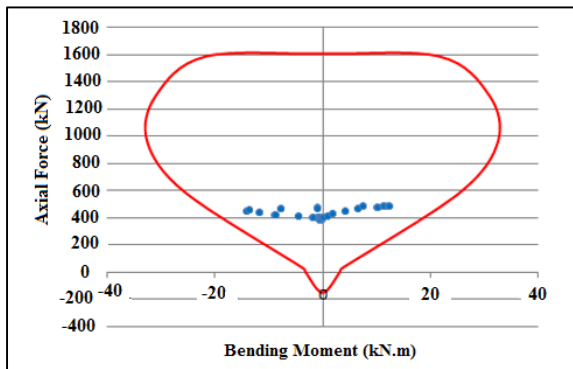
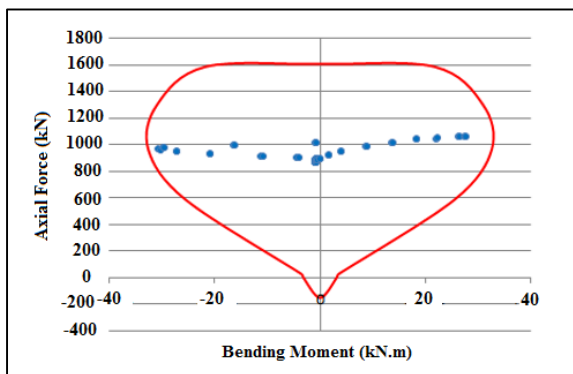

Fig. 15. The shotcrete with a thickness of 12 cm and a layer of steel mesh.



(a)



(b)

Fig. 16. The interaction diagrams of the support system including shotcrete with a layer of steel mesh at: (a) levels of 1870 meter (b) levels of 1830 meter.

3.6.3. The support system is made from shotcrete with a thickness of 12 cm, along with a lattice with a spacing of 2 meters

A restraining lattice with a spacing of 2 meters was used to strengthen the tensile strength of the support system (Fig. 17). Fig. 18 shows a view of the support system simulated in Sap 2000

equal to 2 cm in the interaction diagram. The moment-axial force interaction diagrams for both levels are illustrated in Fig. 16. Due to the high safety factor of this diagram (high distance of the shear force-axial force points from the boundary of the diagram), only the moment-axial force interaction diagram is examined in the following. According to the results, the shotcrete with a thickness of 12 cm, along with a layer of mesh, had sufficient strength.

software. The diameter of the top of the lattice (S2), the diameter of the base (S3), the height of the lattice (H), and the width of the lattice (B) were considered equal to 25 mm, to 20 mm, 115 mm, and 140 mm, respectively. Furthermore, the lattice was considered in the middle of the shotcrete (the distance between the center of the bars and the excavation wall was 25 mm). According to the moment-axial force interaction diagram for both levels, the shotcrete with a thickness of 12 cm, along with a restraining lattice with a spacing of 2 meters had sufficient strength against the loads (Fig. 19).

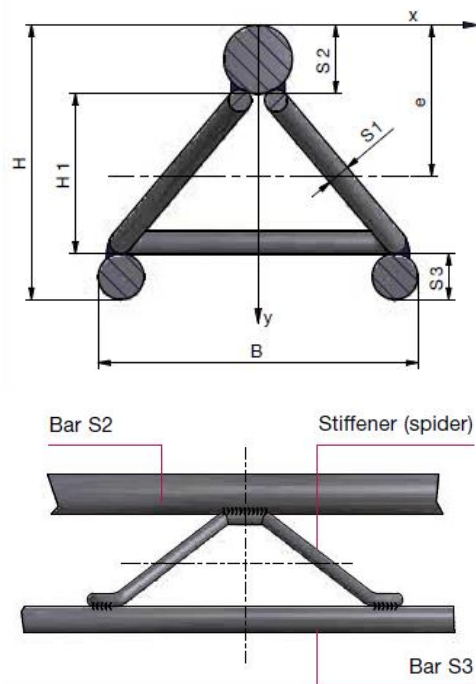

Fig. 17. The components of the restraining lattice.

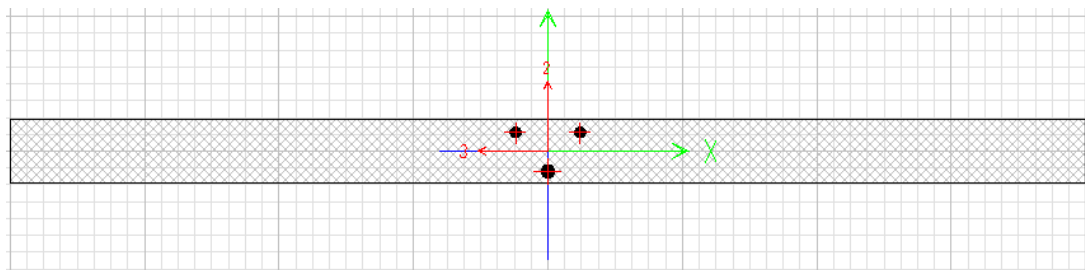
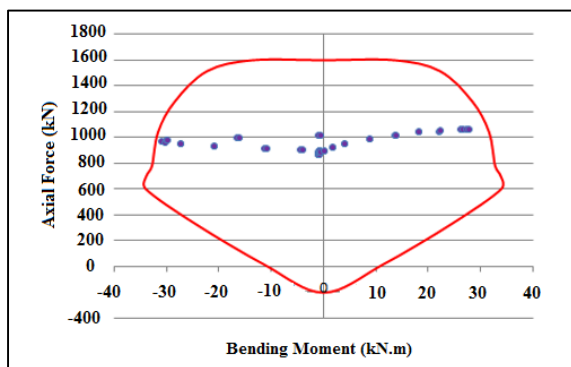
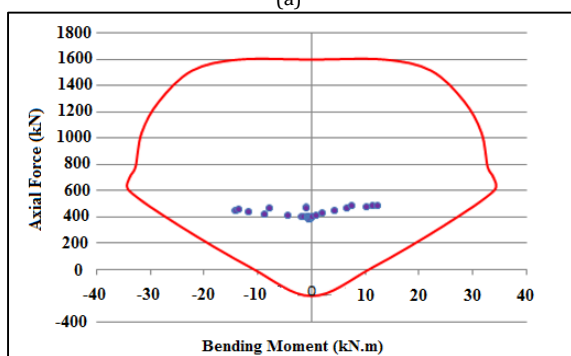

Fig. 18. The shotcrete with a thickness of 12 cm, along with the lattice with a spacing of 2 meters.

According to the diagram of the proposed support system based on Q and the cross-section of the tunnel, the regular installation of rock bolts with a spacing of 2-2.5 meters and a length of 2-2.5 meters is suggested. To examine the effect of the rock bolts installed at the level of 1830 meters, simultaneously with the installation of shotcrete with a thickness of 12 cm (after stress release), the rock bolts with a diameter of 28 mm and a length of 2.4 meters with a transverse spacing of about 1.5 meters and longitudinal spacing of 2 meters were installed in the ceiling and walls using the full-injection method.



(a)



(b)

Fig. 19. The interaction diagram of the support system, including shotcrete with restraining lattice at: (a) level of 1830 meter (b) level of 1870 meter.

4. CONCLUSIONS

This study proposed a support system with fiber shotcrete with a thickness of 90 to 120 mm along with the regular installation of rock bolts for

the initial long sections of the adits in the gold deposit of the Mazraeh-Shadi, according to the curves based on Q and cross-section of the tunnels. The following results were obtained to optimize the support system:

1. At the level of 1870 meters, implementing shotcrete with a thickness of 12 cm and a safety factor of 1.2 was sufficient.

2. At the level of 1830 meters, the shotcrete required to be strengthened. For this purpose, a layer of steel mesh or a restraining lattice with a spacing of 2 meters was used.

3. The implementation of shotcrete with lattice must be performed correctly. If the combination of these elements is not proper, the support system will lose its efficiency.

4. Installing the 2.5-meter bolts in a regular arrangement assuming a continuous medium did not have a significant strengthening effect, so it is recommended to install the bolts locally and in special situations.

5. At the intersections and the tunnel portal, a stronger support system had to be used, and in the tunnel portal the reinforcement measures, such as the implementation of shotcrete on the sloped surface, should be taken.

6. The proposed support system is sufficient and appropriate given the relatively small dimension of the tunnels and their temporary use and according to the Sakurai criterion, the experimental methods, and the engineering judgment.

REFERENCES

- [1] Chryssanthakis, P., Barton, N., Lorig, L. and Christianson, M. (1997). Numerical simulation of fiber reinforced shotcrete in a tunnel using the discrete element method. *International Journal of Rock Mechanics and Mining Sciences*, 34(3-4): 54-e1.
- [2] Bhasin, R. and Høeg, K. (1998). Parametric study for a large cavern in jointed rock using a distinct element model (UDEC-BB). *International Journal of Rock Mechanics and Mining Sciences*, 35(1): 17-29.

- [3] Shen, B. and Barton, N. (1997). The disturbed zone around tunnels in jointed rock masses. *International Journal of Rock Mechanics and Mining Sciences*, 34(1): 117-126.
- [4] Fekete, S. and Diederichs, M. (2013). Integration of three-dimensional laser scanning with discontinuum modelling for stability analysis of tunnels in blocky rockmasses. *International Journal of Rock Mechanics and Mining Sciences*, 57: 11-23.
- [5] Golpasand, M.B., Do, N.A., Dias, D. and Nikudel, M.R. (2018). Effect of the lateral earth pressure coefficient on settlements during mechanized tunneling. *Geomechanics and Engineering*, 16(6): 643-654.
- [6] Darbor, M., Chakeri, H. and Asgharzadeh Dizaj, M. (2021). Investigation of the effect of different parameters on the penetration rate of earth pressure balance boring machine using fuzzy and neuro-fuzzy methods, and metaheuristic algorithms (A case study: Tabriz metro line 2). *Journal of Analytical and Numerical Methods in Mining Engineering*, 10(25): 43-60.
- [7] Behzadi Nezhad, H., Faramarzi, L. and Darbor, M. (2017). Stability analysis and support system design of penstock tunnels bifurcation with headrace tunnel of Rudbare-Lorestan dam project. *Journal of Analytical and Numerical Methods in Mining Engineering*, 7(13): 113-123.
- [8] Palassi, M. and Qoreishi, S.M. (2006). Calculating the GRC for tunnels supported by grouted rockbolts. In *Geotechnical aspects of underground construction in soft ground*. Proc, 5th International Conference of TC 28 of the ISSMGE, Netherlands, 15-17 June, 645-649.
- [9] Sharifzadeh, M., Shahriar, K. and Ashrafi, E. (2008). Stability analysis and design of support system in main adit of Jajarm bauxite underground mines, Proc, 2nd Iranian Mining Engineering Conference, Tehran, 199-206.
- [10] Wang, S., Zheng, H., Li, C. and Ge, X. (2011). A finite element implementation of strain-softening rock mass. *International Journal of Rock Mechanics and Mining Sciences*, 48(1): 67-76.
- [11] Xing, Y., Kulatilake, P.H.S.W. and Sandbak, L.A. (2017). Rock mass stability investigation around tunnels in an underground mine in USA. *Geotechnical and Geological Engineering*, 35: 45-67.
- [12] Rahmannerjad, R., Kargar, A.R., Maazallahi, V. and Ghotbi-Ravandi, E. (2015). Analytical analysis of ultimate ground pressure on tunnel support system. *Journal of Mining and Environment*, 6(2): 151-157.
- [13] Xu, C., Xia, C. and Han, C. (2021). Modified ground response curve (GRC) in strain-softening rock mass based on the generalized Zhang-Zhu strength criterion considering over-excavation. *Underground Space*, 6(5): 585-602.
- [14] Brown, E.T. and Hoek, E. (1980). *Underground excavations in rock*, CRC Press.
- [15] Brown, E.T. (1981). *ISRM suggested methods. Rock characterization testing and monitoring*, London: Royal School of Mines.
- [16] Hoek, E. and Brown, E.T. (1997). Practical estimates of rock mass strength. *International Journal of Rock Mechanics and Mining Sciences*, 34(8): 1165-1186.
- [17] Barton, N. (1988). Rock mass classification and tunnel reinforcement selection using the Q-system. In *Symposium on Rock Classification Systems for Engineering Purposes*, Cincinnati, Ohio, USA.
- [18] Terzaghi, K. (1946). Rock defects and loads on tunnel supports. Proc, *Rock Tunneling with Steel Supports*. Commercial Shearing and Stamping, Youngstown, p. 271.